

GERPAAS underfloor cable trunkings are manufactured of mild steel and also stainless steel raw material as per your requirements.

1, 2, 3 compartment underfloor cable trunkings available in standard. Please contact us for your custom requirements.

- Cable management systems
- Marine type cable supports
- Strut channels, support systems
- Earthing systems
- Lightning protection systems
- Stone fixings
- Steel lintels
- Other building products

Visit us online at www.gerpaas.com

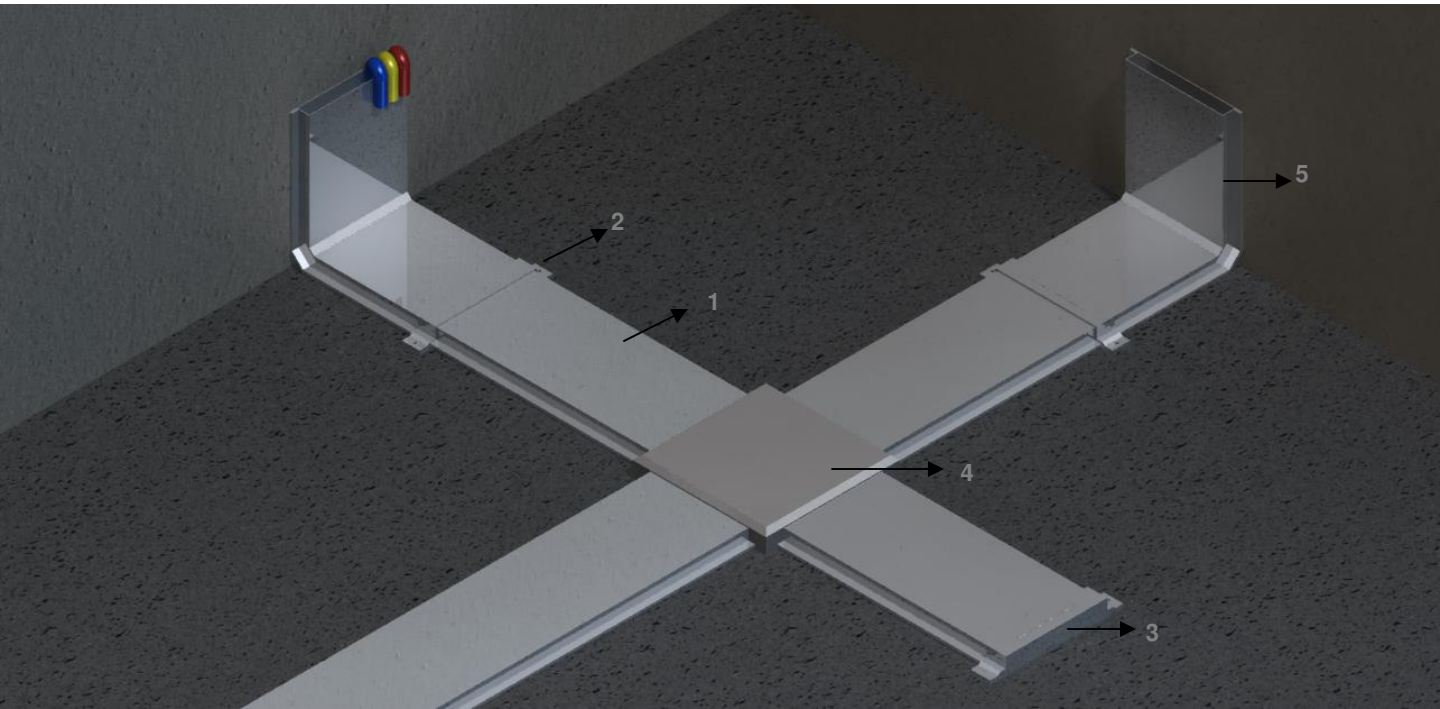

UNDERFLOOR CABLE TRUNKINGS

- 1)- GE-DAK1
- 2)- GE-DAK-EK
- 3)- GE-DAK-SON
- 4)- GE-DKDB-1
- 5)- GE-DAK1-D90

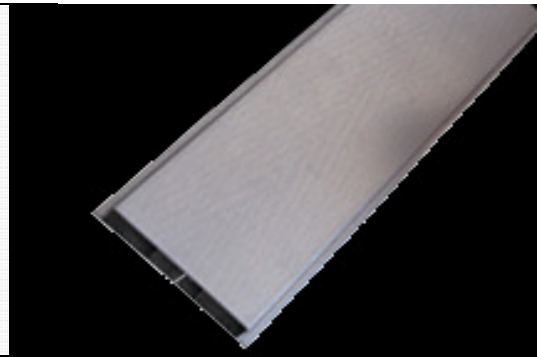

GE-DAK1

Underfloor cable ducting system
 Döşeme altı kablo kanalı
 Под полы кабельных лотков

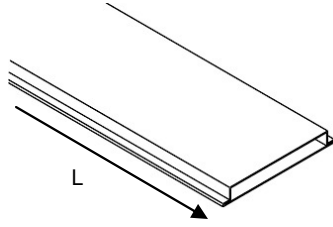
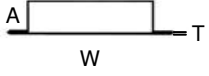

Part No	T	W	A	L	kg/m
GE-DAK1-17-A25	1	175	25	3000	3,50
GE-DAK1-17-A28	1	175	28	3000	4,00
GE-DAK1-17-A30	1	175	30	3000	4,50

SS4 SS6 EG HDG

GE-DAK2

Two Compartment Underfloor cable ducting system
 İki kompartmanlı döşeme altı kablo kanalı
 Под полы кабельных лотков

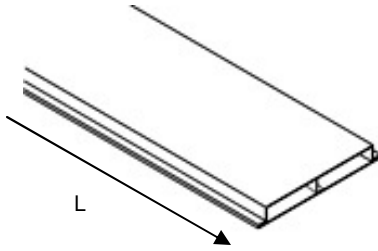
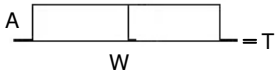

Part No	T	W	A	L	kg/m
GE-DAK2-25-A25	1,2	250	25	3000	5,70
GE-DAK2-25-A28	1,2	250	28	3000	6,20
GE-DAK2-25-A30	1,2	250	30	3000	6,80

SS4 SS6 EG HDG

GE-DAK3

Three Compartment Underfloor cable ducting system
 Üç kompartmanlı döşeme altı kablo kanalı
 Под полы кабельных лотков

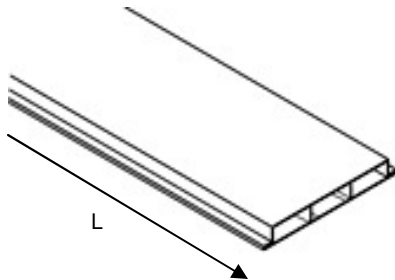
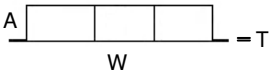

Part No	T	W	A	L	kg/m
GE-DAK3-27-A25	1,5	270	25	3000	7,70
GE-DAK3-27-A28	1,5	270	28	3000	8,40
GE-DAK3-27-A30	1,5	270	30	3000	9,20

SS4 SS6 EG HDG

Material options: Stainless steel AISI 304 (L) (A2) / AISI 316 (L) (A4), ST-37-42 Mild Steel, Corten A, Pregalvanized steel, Aluminum
 Finish options : Hot Dip Galvanized to EN 1461, Electrogalvanized to TS 149, Electrostatic Paint Coated, Prime coated

GE-DAK1-D90

90° Elbow
 90° Dirsek
 90 градуса локоть

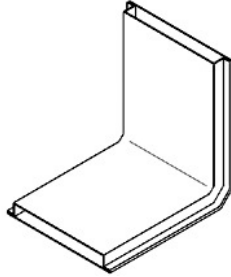
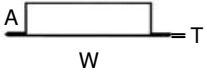

Part No	T	W	A	L	kg
GE-DAK1-D90-17-A25	1	175	25	130	0,90
GE-DAK1-D90-17-A28	1	175	28	130	1,00
GE-DAK1-D90-17-A30	1	175	30	130	1,15

SS4 SS6 EG HDG

GE-DAK2-D90

90° Elbow
 90° Dirsek
 90 градуса локоть

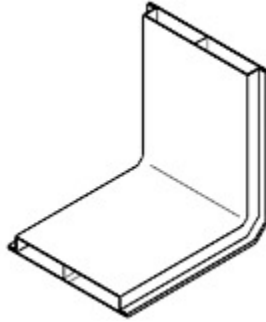
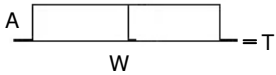

Part No	T	W	A	L	kg
GE-DAK2-D90-25-A25	1,2	250	25	130	1,43
GE-DAK2-D90-25-A28	1,2	250	28	130	1,60
GE-DAK2-D90-25-A30	1,2	250	30	130	1,75

SS4 SS6 EG HDG

GE-DAK3-D90

90° Elbow
 90° Dirsek
 90 градуса локоть

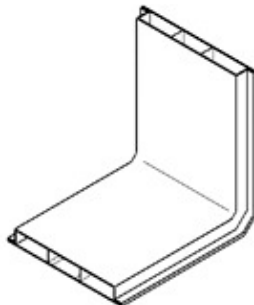
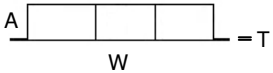

Part No	T	W	A	L	kg
GE-DAK3-D90-27-A25	1,5	270	25	130	2,00
GE-DAK3-D90-27-A28	1,5	270	28	130	2,20
GE-DAK3-D90-27-A30	1,5	270	30	130	2,40

SS4 SS6 EG HDG

Material options: Stainless steel AISI 304 (L) (A2) / AISI 316 (L) (A4), ST-37-42 Mild Steel, Corten A, Pregalvanized steel, Aluminum
 Finish options : Hot Dip Galvanized to EN 1461, Electrogalvanized to TS 149, Electrostatic Paint Coated, Prime coated

GE-DAK-SON

End Plate
 Sonlandırma Elemanı
 Единица конца

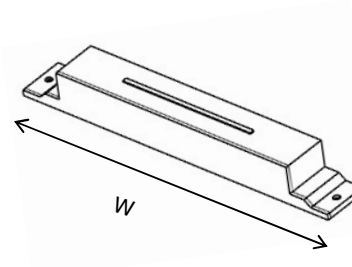

Part No	T	W	A	kg
GE-DAK-SON-17-A25	1	175	25	0,90
GE-DAK-SON-17-A28	1	175	28	1,00
GE-DAK-SON-17-A30	1	175	30	1,15
GE-DAK-SON-25-A25	1,2	250	25	1,43
GE-DAK-SON-25-A28	1,2	250	28	1,60
GE-DAK-SON-25-A30	1,2	250	30	1,75
GE-DAK-SON-27-A25	1,5	270	25	2,00
GE-DAK-SON-27-A28	1,5	270	28	2,20
GE-DAK-SON-27-A30	1,5	270	30	2,40

SS4 SS6 EG HDG

GE-DAK-EK

Connector
 Ek elemanı
 Связующий элемент

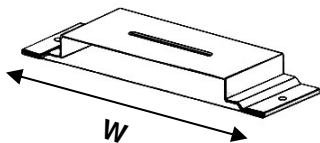

Part No	T	W	A	kg
GE-DAK-EK-17-A25	1	175	25	0,18
GE-DAK-EK-17-A28	1	175	28	0,19
GE-DAK-EK-17-A30	1	175	30	0,20
GE-DAK-EK-25-A25	1,2	250	25	0,30
GE-DAK-EK-25-A28	1,2	250	28	0,33
GE-DAK-EK-25-A30	1,2	250	30	0,35
GE-DAK-EK-27-A25	1,5	270	25	0,37
GE-DAK-EK-27-A28	1,5	270	28	0,40
GE-DAK-EK-27-A30	1,5	270	30	0,43

SS4 SS6 EG HDG

Material options: Stainless steel AISI 304 (L) (A2) / AISI 316 (L) (A4), ST-37-42 Mild Steel, Corten A, Pregalvanized steel, Aluminum
 Finish options : Hot Dip Galvanized to EN 1461, Electrogalvanized to TS 149, Electrostatic Paint Coated, Prime coated

GE-UFT1

Underfloor cable ducting system

Döşeme altı kablo kanalı

Под полы кабельных лотков

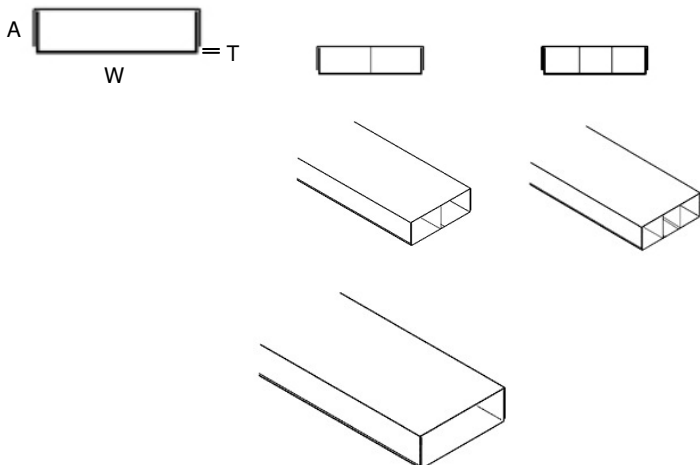

Part No	T	W	A	L	kg/m
GE-UFT1-5-A25	1,5	50	25	3000	2,30
GE-UFT1-7-A25	1,5	75	25	3000	2,90
GE-UFT1-10-A25	1,5	100	25	3000	3,50
GE-UFT1-5-A32	1,5	50	32	3000	2,50
GE-UFT1-7-A32	1,5	75	32	3000	3,10
GE-UFT1-10-A32	1,5	100	32	3000	3,70
GE-UFT1-5-A38	1,5	50	38	3000	2,80
GE-UFT1-7-A38	1,5	75	38	3000	3,40
GE-UFT1-10-A38	1,5	100	38	3000	4,00
GE-UFT1-5-A40	1,5	50	40	3000	3,10
GE-UFT1-7-A40	1,5	75	40	3000	3,70
GE-UFT1-10-A40	1,5	100	40	3000	4,30

SS4 SS6 EG HDG

GE-UFT1-D90

90° Elbow

90° Dirsek

90 градуса локоть

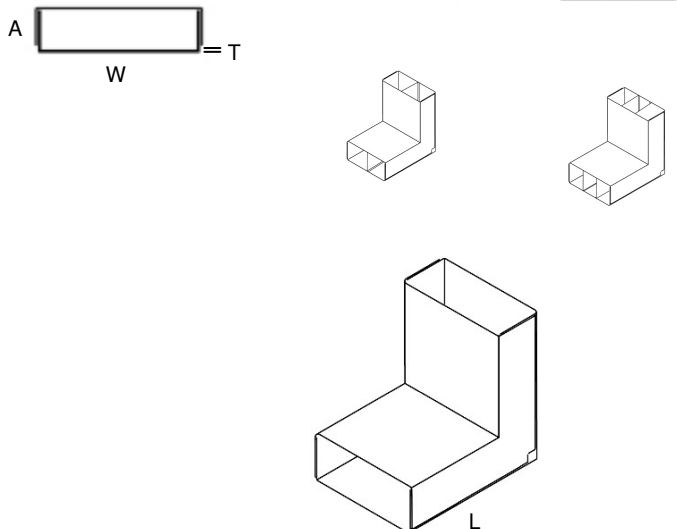

Part No	T	W	A	L	kg
GE-UFT1-D90-5-A25	1,5	50	25	200	0,95
GE-UFT1-D90-7-A25	1,5	75	25	200	1,20
GE-UFT1-D90-10-A25	1,5	100	25	200	1,40
GE-UFT1-D90-5-A32	1,5	50	32	200	1,00
GE-UFT1-D90-7-A32	1,5	75	32	200	1,25
GE-UFT1-D90-10-A32	1,5	100	32	200	1,50
GE-UFT1-D90-5-A38	1,5	50	38	200	1,15
GE-UFT1-D90-7-A38	1,5	75	38	200	1,40
GE-UFT1-D90-10-A38	1,5	100	38	200	1,60
GE-UFT1-D90-5-A40	1,5	50	40	200	1,25
GE-UFT1-D90-7-A40	1,5	75	40	200	1,50
GE-UFT1-D90-10-A40	1,5	100	40	200	1,75

SS4 SS6 EG HDG

Material options: Stainless steel AISI 304 (L) (A2) / AISI 316 (L) (A4), ST-37-42 Mild Steel, Corten A, Pregalvanized steel, Aluminum
 Finish options : Hot Dip Galvanized to EN 1461, Electrogalvanized to TS 149, Electrostatic Paint Coated, Prime coated

GE-UFT-SON

End Plate
 Sonlandırma Elemanı
 Единица конца

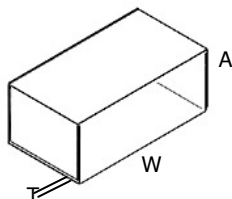

Part No	T	W	A	kg
GE-UFT-SON-5-A25	1,5	50	25	0,23
GE-UFT-SON-7-A25	1,5	75	25	0,29
GE-UFT-SON-10-A25	1,5	100	25	0,35
GE-UFT-SON-5-A32	1,5	50	32	0,25
GE-UFT-SON-7-A32	1,5	75	32	0,31
GE-UFT-SON-10-A32	1,5	100	32	0,37
GE-UFT-SON-5-A38	1,5	50	38	0,28
GE-UFT-SON-7-A38	1,5	75	38	0,34
GE-UFT-SON-10-A38	1,5	100	38	0,40
GE-UFT-SON-5-A40	1,5	50	40	0,31
GE-UFT-SON-7-A40	1,5	75	40	0,37
GE-UFT-SON-10-A40	1,5	100	40	0,43

SS4 SS6 EG HDG

GE-UFT-EK

Connector
 Ek elemanı
 Связующий элемент

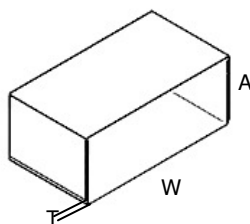

Part No	T	W	A	kg
GE-UFT-EK-5-A25	1,5	50	25	0,25
GE-UFT-SON-7-A25	1,5	75	25	0,30
GE-UFT-SON-10-A25	1,5	100	25	0,40
GE-UFT-SON-5-A32	1,5	50	32	0,27
GE-UFT-SON-7-A32	1,5	75	32	0,35
GE-UFT-SON-10-A32	1,5	100	32	0,40
GE-UFT-SON-5-A38	1,5	50	38	0,30
GE-UFT-SON-7-A38	1,5	75	38	0,37
GE-UFT-SON-10-A38	1,5	100	38	0,45
GE-UFT-SON-5-A40	1,5	50	40	0,35
GE-UFT-SON-7-A40	1,5	75	40	0,40
GE-UFT-SON-10-A40	1,5	100	40	0,50

SS4 SS6 EG HDG

GE-DKDB-1

Junction Box c/w Service Box

Buat, priz kutusu ile birlikte

Подпольные распределительной коробке

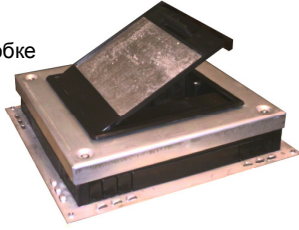

Part No	T	W	A	L	kg
GE-DKDB-1	1,5	270	65	350	2,40

Used as crossing or connection box in underfloor ducting systems.

Junction box has its individual cover lid with the same material thickness.

Underfloor cable trays (ducts) can be inserted and be connected to the junction box through the plastic removable lids on front.

Plastic removable lids provide multi dimensional connections.

Plastic lids enable level adjustment with adjustment bolts.

Adjustment toleration is 15mm.

Hard plastic made heat resistant outlet assembly frame allows connection for 2 power outlets and 3 data outlets.

Underfloor cable tray must be inserted through the plastic removable lids on front.

Outlets must be ordered separately.

Döşeme altı kablo kanalı sistemlerinde bağlantı elemanı veya buati olarak kullanılır.

Kapağı taban sacı ile aynı kalınlıktadır. Buata kanallar yandaki plastik kapaklardan sürülerek monte edilir.

Buatın köşelerinde yer alan civatalar ile buatın alt üniteden yüksekliği ayarlanır.

Buatın içindeki priz kutusunun 3 enerji prizi ve 2 data prizi kapasitesi vardır.

Ayar toleransı 15mm dir.

Prizler ayrıca sipariş edilmelidir.

Используется как переход или соединительной коробке в пол воздуховоды систем.

Распределительная коробка имеет свой индивидуальный крышка крышка с той же толщины материала. Обложка крышка Mountable

С помощью болтов. Подпольные кабельных лотков (протоки) может быть добавлено и быть подключены к распределительной коробке через Съёмная пластиковая крышка на фронт.

Пластиковые крышки позволить регулировки уровня с регулировкой болтов. Настройка терпимым является 15 мм.

Жаростойкие Ассамблеи розетки пластика позволяет связи в течение 3 (электрический) + 2 (данных) точек.

Подпольные кабельного лотка должна быть вставлена через пластиковые съёмные крышки на фронт.

Пластиковые крышки позволить регулировки уровня с регулировкой болтов. Розеток должны быть заказаны отдельно.

Service box

Ideal solution for use in underfloor energy systems in offices, business centers, and more.

Material: Polymid plastic.

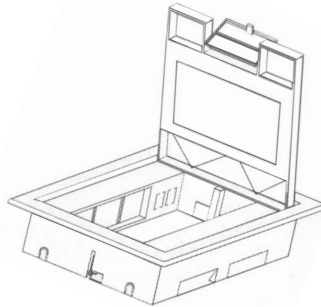

Outlets



GE-OUT-1
UPS outlet



GE-OUT-2
Earth outlet



GE-OUT-3
Phone socket