

# GERPAAS®

Cable trays  
Chemin de câbles  
Kabelrinnen  
Кабельные лотки  
Kablo kanalları



**GERPAAS cable trunkings are ideal for use in areas where hygiene and cleanliness is a priority. Cable trunkings are available up to 3 compartments in standard and are supplied in lengths of 3 meters.**

**Stainless steel  
and galvanized  
cable trunkings  
available in  
standard production.**

- Cable management systems
- Marine type cable supports
- Strut channels, support systems
- Earthing systems
- Lightning protection systems
- Stone fixings
- Steel lintels
- Other building products

Visit us online at [www.gerpaas.com](http://www.gerpaas.com)

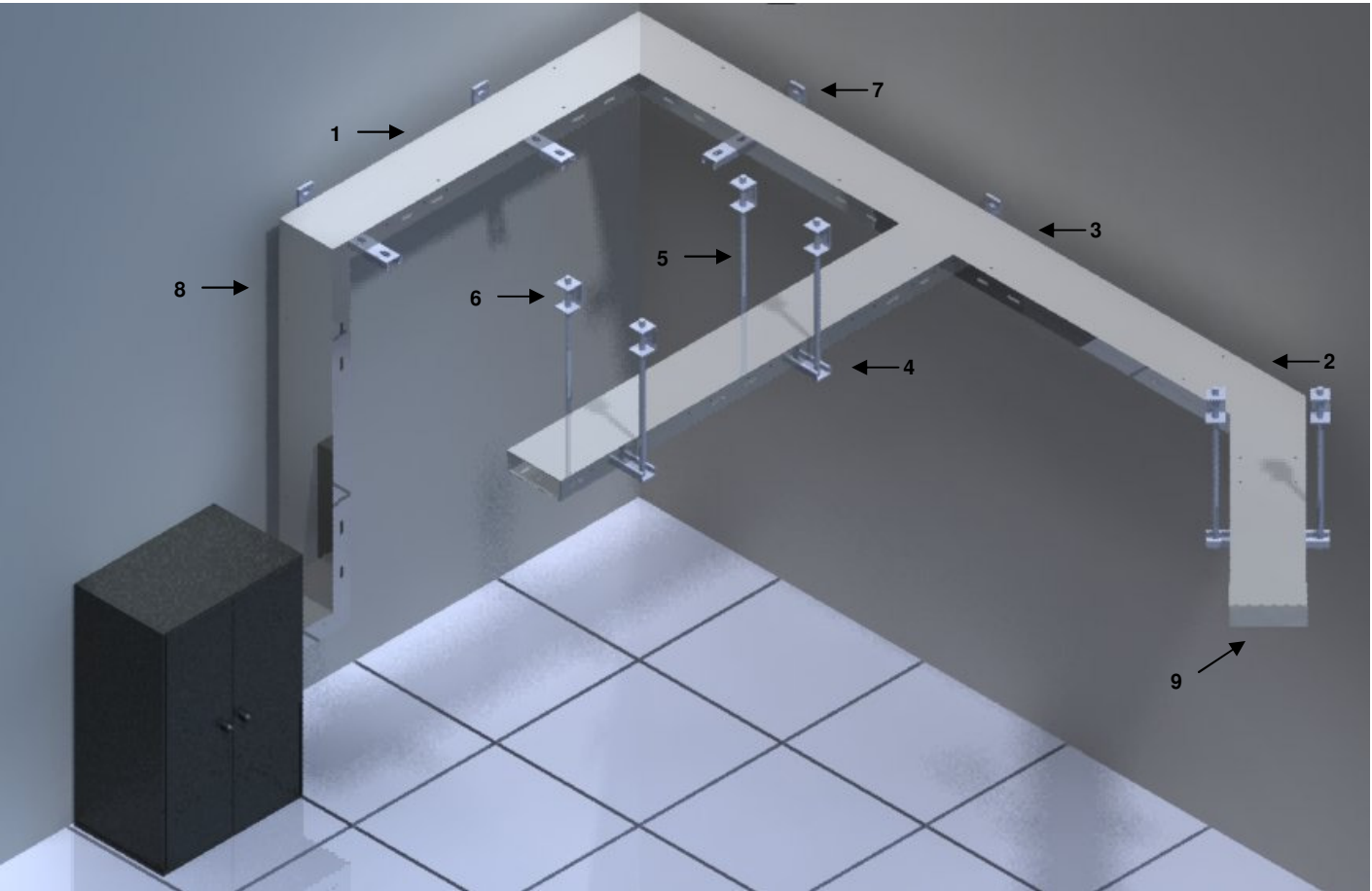

- |                  |                   |
|------------------|-------------------|
| 1)- GE-TRNK1     | 6)- GE-AE-2       |
| 2)- GE-TRNK1-D45 | 7)- GE-KDC        |
| 3)- GE-TRNK1-T   | 8)- GE-TRNK1-VB90 |
| 4)- GE-AE-5U     | 9)- GE-SON        |
| 5)- GE-KAT       |                   |



## Cable Trunkings

# 50

**GE-TRNK1-A50**  
 Cable trunking  
 Tranket  
 кабельных лотков

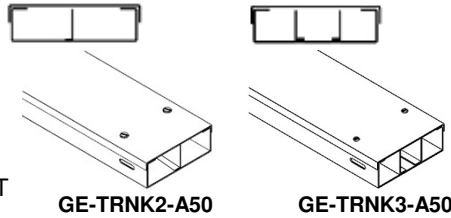

**GE-TRNK2-A50**

**GE-TRNK3-A50**

Part No	T	W	A	L	kg/m
GE-TRNK1-5-A50	1.0	50	50	3000	1,85
GE-TRNK1-7-A50	1.2	75	50	3000	2,70
GE-TRNK1-10-A50	1.2	100	50	3000	3,20
GE-TRNK1-15-A50	1.2	150	50	3000	4,00
GE-TRNK1-20-A50	1.5	200	50	3000	6,40
GE-TRNK1-25-A50	1.5	250	50	3000	7,60
GE-TRNK1-30-A50	1.5	300	50	3000	8,80

SS4 SS6 EG HDG

Standard lengths: 3m  
 Available in additional lengths upto 5m upon request.  
 Perforated with slot holes in 10.3 x 26mm.

**GE-TRNK1-D90-A50**

90° Flat Bend  
 90° Yatay Dönüş Elemanı  
 Секция угловая горизонтальная 90°

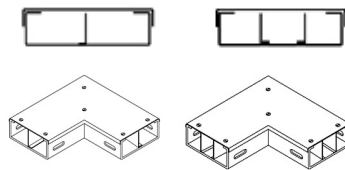

Part No	T	W	A	L	kg
GE-TRNK1-D90-5-A50	1.0	50	50	170	0,55
GE-TRNK1-D90-7-A50	1.2	75	50	195	0,85
GE-TRNK1-D90-10-A50	1.2	100	50	220	1,10
GE-TRNK1-D90-15-A50	1.2	150	50	270	1,60
GE-TRNK1-D90-20-A50	1.5	200	50	320	2,80
GE-TRNK1-D90-25-A50	1.5	250	50	370	3,70
GE-TRNK1-D90-30-A50	1.5	300	50	420	4,75

SS4 SS6 EG HDG

Sample order: GE-TRNK1 D90 5 A15 HDG  
 (Series + Product +Width + Height + Finish)

**GE-TRNK1-D45-A50**

45° Flat Bend  
 45° Yatay Dönüş Elemanı  
 Секция угловая горизонтальная 90°

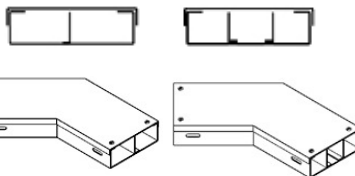

Part No	T	W	A	L	kg
GE-TRNK1-D45-5-A50	1.0	50	50	320	0,60
GE-TRNK1-D45-7-A50	1.2	75	50	350	1,00
GE-TRNK1-D45-10-A50	1.2	100	50	380	1,20
GE-TRNK1-D45-15-A50	1.2	150	50	430	1,70
GE-TRNK1-D45-20-A50	1.5	200	50	480	3,00
GE-TRNK1-D45-25-A50	1.5	250	50	530	4,00
GE-TRNK1-D45-30-A50	1.5	300	50	580	5,10

SS4 SS6 EG HDG

**GE-TRNK-EK**

Splice Plate  
 Ek Parçası  
 Связующий элемент

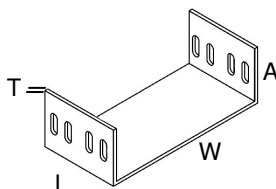

Part No	T	W	A	L	kg
GE-TRNK-EK-5-A50	1.0	50	50	100	0,12
GE-TRNK-EK-7-A50	1.2	75	50	100	0,17
GE-TRNK-EK-10-A50	1.2	100	50	100	0,20
GE-TRNK-EK-15-A50	1.2	150	50	100	0,25
GE-TRNK-EK-20-A50	1.5	200	50	100	0,36
GE-TRNK-EK-25-A50	1.5	250	50	100	0,42
GE-TRNK-EK-30-A50	1.5	300	50	100	0,48

Material options: Stainless steel AISI 304 (L) (A2) / AISI 316 (L) (A4), ST-37-42 Mild Steel, Corten A, Pregalvanized steel, Aluminum  
 Finish options : Hot Dip Galvanized to EN 1461, Electrogalvanized to TS 149, Electrostatic Paint Coated, Prime coated

## Cable Trunkings

# 50

### GE-TRNK1-T-A50

Tee  
 T Elemanı  
 T образное азветвление

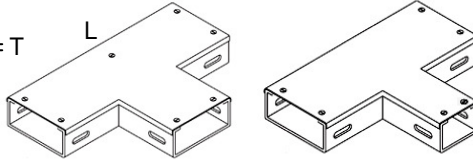
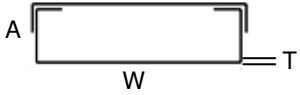
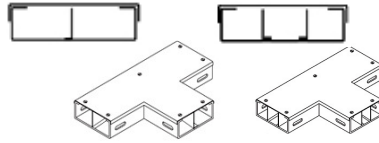

Part No	T	W	A	L	kg
GE-TRNK1-T-5-A50	1.0	50	50	280	0,75
GE-TRNK1-T-7-A50	1.2	75	50	305	1,15
GE-TRNK1-T-10-A50	1.2	100	50	330	1,65
GE-TRNK1-T-15-A50	1.2	150	50	380	2,40
GE-TRNK1-T-20-A50	1.5	200	50	430	4,20
GE-TRNK1-T-25-A50	1.5	250	50	480	5,50
GE-TRNK1-T-30-A50	1.5	300	50	530	7,15

**SS4** **SS6** **EG** **HDG**

### GE-TRNK1-DB-A50

Crossing  
 Dörtlü Bağlantı Elemanı  
 Секция крестообразная

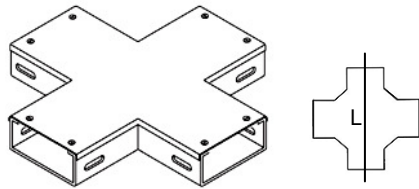
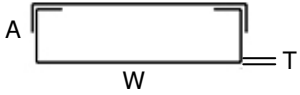
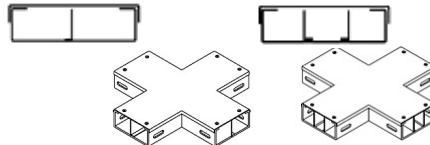

Part No	T	W	A	L	kg
GE-TRNK1-DB-5-A50	1.0	50	50	280	0,95
GE-TRNK1-DB-7-A50	1.2	75	50	305	1,45
GE-TRNK1-DB-10-A50	1.2	100	50	330	2,10
GE-TRNK1-DB-15-A50	1.2	150	50	380	3,00
GE-TRNK1-DB-20-A50	1.5	200	50	430	5,20
GE-TRNK1-DB-25-A50	1.5	250	50	480	6,90
GE-TRNK1-DB-30-A50	1.5	300	50	530	8,90

**SS4** **SS6** **EG** **HDG**

### GE-TRNK1-VB90-A50

90° Vertical Bend  
 90° Dikey Çıkış elemanı  
 Внешний угловой элемент 90°

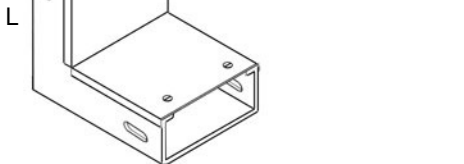
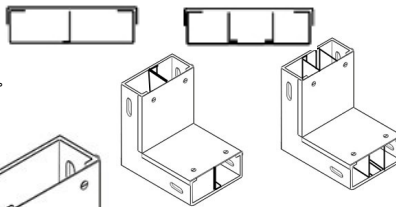

Part No	T	W	A	L	kg
GE-TRNK1-VB90-5-A50	1.0	50	50	200	0,37
GE-TRNK1-VB90-7-A50	1.2	75	50	200	0,54
GE-TRNK1-VB90-10-A50	1.2	100	50	200	0,64
GE-TRNK1-VB90-15-A50	1.2	150	50	200	0,80
GE-TRNK1-VB90-20-A50	1.5	200	50	200	1,30
GE-TRNK1-VB90-25-A50	1.5	250	50	200	1,50
GE-TRNK1-VB90-30-A50	1.5	300	50	200	1,80

**SS4** **SS6** **EG** **HDG**

### GE-TRNK1-VB45-A50

45° Vertical Bend  
 45° Dikey Çıkış elemanı  
 Внешний угловой элемент 45°

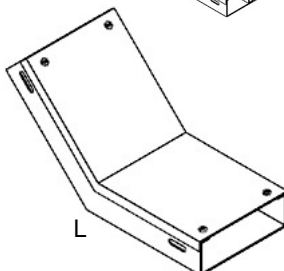
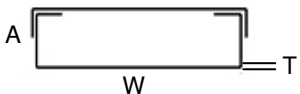
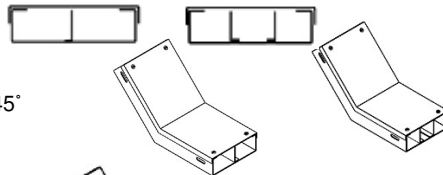

Part No	T	W	A	L	kg
GE-TRNK1-VB45-5-A50	1.0	50	50	340	0,65
GE-TRNK1-VB45-7-A50	1.2	75	50	340	0,92
GE-TRNK1-VB45-10-A50	1.2	100	50	340	1,10
GE-TRNK1-VB45-15-A50	1.2	150	50	340	1,40
GE-TRNK1-VB45-20-A50	1.5	200	50	340	2,20
GE-TRNK1-VB45-25-A50	1.5	250	50	340	2,60
GE-TRNK1-VB45-30-A50	1.5	300	50	340	3,00

**SS4** **SS6** **EG** **HDG**

## Cable Trunkings

## 75

**GE-TRNK1-A75**  
 Cable trunking  
 Tranket  
 кабельных лотков

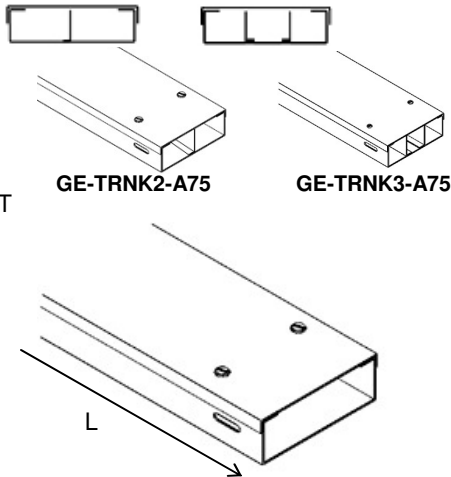

Part No	T	W	A	L	kg/m
GE-TRNK1-7-A75	1.2	75	75	3000	3,20
GE-TRNK1-10-A75	1.2	100	75	3000	3,70
GE-TRNK1-15-A75	1.2	150	75	3000	4,60
GE-TRNK1-20-A75	1.5	200	75	3000	7,00
GE-TRNK1-25-A75	1.5	250	75	3000	8,20
GE-TRNK1-30-A75	1.5	300	75	3000	9,40

SS4 SS6 EG HDG

Standard lengths: 3m  
 Available in additional lengths upto 5m upon request.  
 Perforated with slot holes in 10.3 x 26mm.

**GE-TRNK1-D90-A75**

90° Flat Bend  
 90° Yatay Dönüş Elemanı  
 Секция угловая горизонтальная 90°

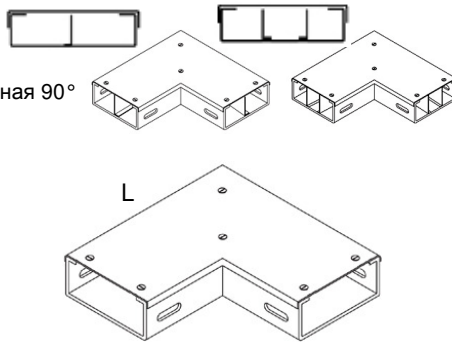
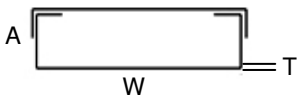

Part No	T	W	A	L	kg
GE-TRNK1-D90-7-A75	1.2	75	75	195	1,00
GE-TRNK1-D90-10-A75	1.2	100	75	220	1,30
GE-TRNK1-D90-15-A75	1.2	150	75	270	1,80
GE-TRNK1-D90-20-A75	1.5	200	75	320	3,10
GE-TRNK1-D90-25-A75	1.5	250	75	370	4,00
GE-TRNK1-D90-30-A75	1.5	300	75	420	5,10

SS4 SS6 EG HDG

Sample order: GE-TRNK1 D90 5 A75 HDG  
 (Series + Product +Width + Height + Finish)

**GE-TRNK1-D45-A75**

45° Flat Bend  
 45° Yatay Dönüş Elemanı  
 Секция угловая горизонтальная 90°

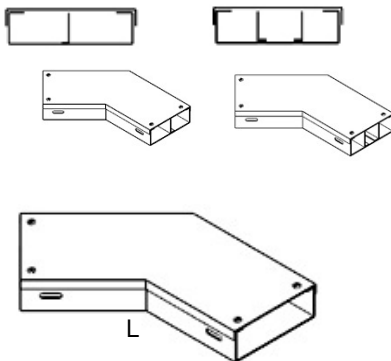

Part No	T	W	A	L	kg
GE-TRNK1-D45-7-A75	1.2	75	75	350	1,15
GE-TRNK1-D45-10-A75	1.2	100	75	380	1,40
GE-TRNK1-D45-15-A75	1.2	150	75	430	2,00
GE-TRNK1-D45-20-A75	1.5	200	75	480	3,40
GE-TRNK1-D45-25-A75	1.5	250	75	530	4,35
GE-TRNK1-D45-30-A75	1.5	300	75	580	5,50

SS4 SS6 EG HDG

**GE-TRNK-EK**

Splice Plate  
 Ek Parçası  
 Связующий элемент

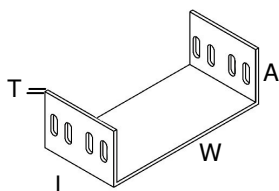

Part No	T	W	A	L	kg
GE-TRNK-EK-7-A75	1.2	75	75	100	0,22
GE-TRNK-EK-10-A75	1.2	100	75	100	0,25
GE-TRNK-EK-15-A75	1.2	150	75	100	0,30
GE-TRNK-EK-20-A75	1.5	200	75	100	0,42
GE-TRNK-EK-25-A75	1.5	250	75	100	0,48
GE-TRNK-EK-30-A75	1.5	300	75	100	0,54

Material options: Stainless steel AISI 304 (L) (A2) / AISI 316 (L) (A4), ST-37-42 Mild Steel, Corten A, Pregalvanized steel, Aluminum  
 Finish options : Hot Dip Galvanized to EN 1461, Electrogalvanized to TS 149, Electrostatic Paint Coated, Prime coated

## Cable Trunkings

# 75

### GE-TRNK1-T-A75

Tee  
 T Elemanı  
 T образное азветвление

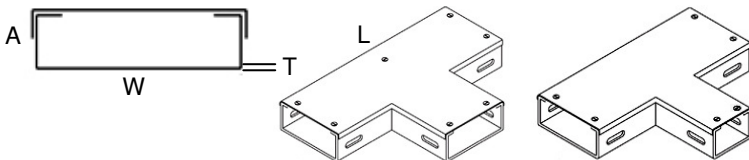

Part No	T	W	A	L	kg
GE-TRNK1-T-7-A75	1.2	75	75	305	1,50
GE-TRNK1-T-10-A75	1.2	100	75	330	1,95
GE-TRNK1-T-15-A75	1.2	150	75	380	2,70
GE-TRNK1-T-20-A75	1.5	200	75	430	4,65
GE-TRNK1-T-25-A75	1.5	250	75	480	6,00
GE-TRNK1-T-30-A75	1.5	300	75	530	7,65

SS4 SS6 EG HDG

### GE-TRNK1-DB-A75

Crossing  
 Dörtlü Bağlantı Elemanı  
 Секция крестообразная

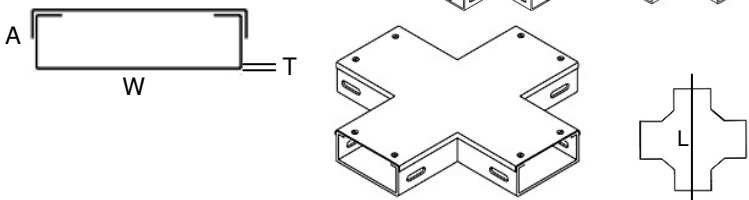

Part No	T	W	A	L	kg
GE-TRNK1-DB-7-A75	1.2	75	75	305	1,90
GE-TRNK1-DB-10-A75	1.2	100	75	330	2,40
GE-TRNK1-DB-15-A75	1.2	150	75	380	3,40
GE-TRNK1-DB-20-A75	1.5	200	75	430	5,80
GE-TRNK1-DB-25-A75	1.5	250	75	480	7,50
GE-TRNK1-DB-30-A75	1.5	300	75	530	9,60

SS4 SS6 EG HDG

### GE-TRNK1-VB90-A75

90° Vertical Bend  
 90° Dikey Çıkış elemanı  
 Внешний угловой элемент 90°

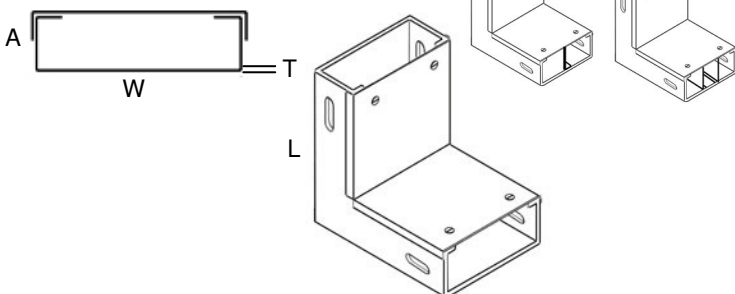

Part No	T	W	A	L	kg
GE-TRNK1-VB90-7-A75	1.2	75	75	200	0,65
GE-TRNK1-VB90-10-A75	1.2	100	75	200	0,75
GE-TRNK1-VB90-15-A75	1.2	150	75	200	0,90
GE-TRNK1-VB90-20-A75	1.5	200	75	200	1,40
GE-TRNK1-VB90-25-A75	1.5	250	75	200	1,70
GE-TRNK1-VB90-30-A75	1.5	300	75	200	2,00

SS4 SS6 EG HDG

### GE-TRNK1-VB45-A75

45° Vertical Bend  
 45° Dikey Çıkış elemanı  
 Внешний угловой элемент 45°

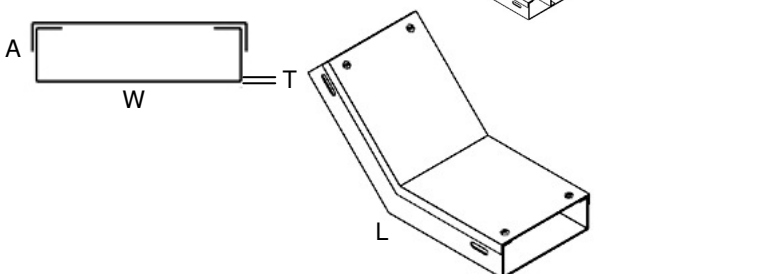

Part No	T	W	A	L	kg
GE-TRNK1-VB45-7-A75	1.2	75	75	340	1,10
GE-TRNK1-VB45-10-A75	1.2	100	75	340	1,30
GE-TRNK1-VB45-15-A75	1.2	150	75	340	1,60
GE-TRNK1-VB45-20-A75	1.5	200	75	340	2,40
GE-TRNK1-VB45-25-A75	1.5	250	75	340	2,80
GE-TRNK1-VB45-30-A75	1.5	300	75	340	3,20

SS4 SS6 EG HDG

## Cable Trunkings

# 100

### GE-TRNK1-A100

Cable trunking  
 Tranket  
 кабельных лотков

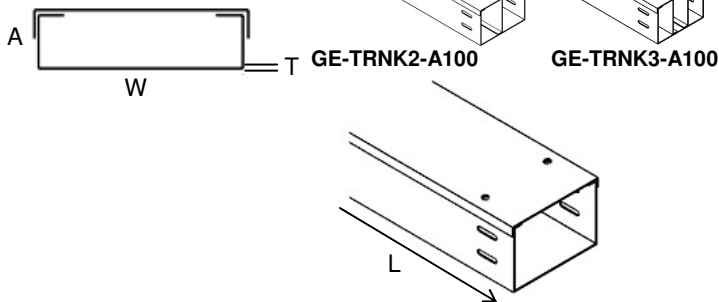

Part No	T	W	A	L	kg/m
GE-TRNK3-10-A100	1.2	100	100	3000	4,14
GE-TRNK3-15-A100	1.2	150	100	3000	5,10
GE-TRNK3-20-A100	1.5	200	100	3000	7,60
GE-TRNK3-25-A100	1.5	250	100	3000	8,80
GE-TRNK3-30-A100	1.5	300	100	3000	10,00

SS4 SS6 EG HDG

Standard lengths: 3m

Available in additional lengths upto 5m upon request.  
 Perforated with slot holes in 10.3 x 26mm.

### GE-TRNK1-D90-A100

90° Flat Bend  
 90° Yatay Dönüş Elemanı  
 Секция угловая горизонтальная 90°

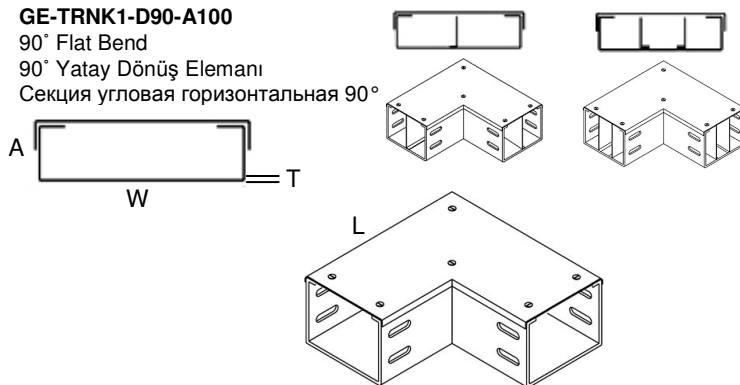

Part No	T	W	A	L	kg
GE-TRNK1-D90-10-A100	1.2	100	100	220	1,40
GE-TRNK1-D90-15-A100	1.2	150	100	270	2,00
GE-TRNK1-D90-20-A100	1.5	200	100	320	3,40
GE-TRNK1-D90-25-A100	1.5	250	100	370	4,30
GE-TRNK1-D90-30-A100	1.5	300	100	420	5,40

SS4 SS6 EG HDG

Sample order: GE-TRNK1 D90 5 A100 HDG  
 (Series + Product +Width + Height + Finish)

### GE-TRNK1-D45-A100

45° Flat Bend  
 45° Yatay Dönüş Elemanı  
 Секция угловая горизонтальная 90°



Part No	T	W	A	L	kg
GE-TRNK1-D45-10-A100	1.2	100	100	380	1,60
GE-TRNK1-D45-15-A100	1.2	150	100	430	2,20
GE-TRNK1-D45-20-A100	1.5	200	100	480	3,70
GE-TRNK1-D45-25-A100	1.5	250	100	530	4,60
GE-TRNK1-D45-30-A100	1.5	300	100	580	5,80

SS4 SS6 EG HDG

### GE-TRNK-EK

Splice Plate  
 Ek Parçası  
 Связующий элемент

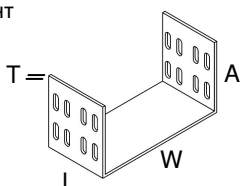

Part No	T	W	A	L	kg
GE-TRNK-EK-10-A100	1.2	100	100	100	0,30
GE-TRNK-EK-15-A100	1.2	150	100	100	0,35
GE-TRNK-EK-20-A100	1.5	200	100	100	0,48
GE-TRNK-EK-25-A100	1.5	250	100	100	0,54
GE-TRNK-EK-30-A100	1.5	300	100	100	0,60

SS4 SS6 EG HDG



Material options: Stainless steel AISI 304 (L) (A2) / AISI 316 (L) (A4), ST-37-42 Mild Steel, Corten A, Pregalvanized steel, Aluminum  
 Finish options : Hot Dip Galvanized to EN 1461, Electrogalvanized to TS 149, Electrostatic Paint Coated, Prime coated

## Cable Trunkings

# 100

### GE-TRNK1-T-A100

Tee  
 T Elemanı  
 T образное азветвление

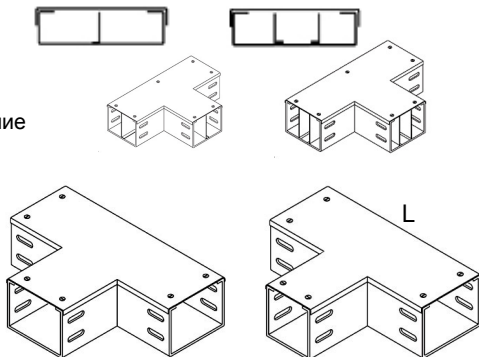
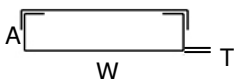

Part No	T	W	A	L	kg
GE-TRNK1-T-10-A100	1.2	100	100	330	2,10
GE-TRNK1-T-15-A100	1.2	150	100	380	3,00
GE-TRNK1-T-20-A100	1.5	200	100	430	5,10
GE-TRNK1-T-25-A100	1.5	250	100	480	6,45
GE-TRNK1-T-30-A100	1.5	300	100	530	8,10

SS4 SS6 EG HDG

### GE-TRNK1-DB-A100

Crossing  
 Dörtlü Bağlantı Elemanı  
 Секция крестообразная

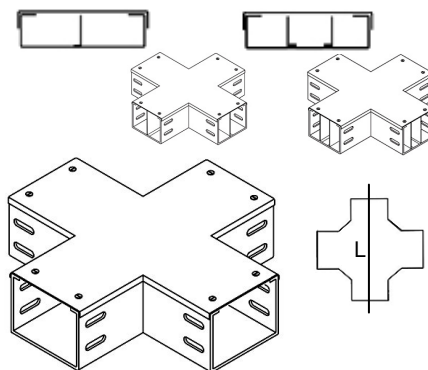
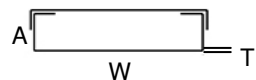

Part No	T	W	A	L	kg
GE-TRNK1-DB-10-A100	1.2	100	100	330	2,60
GE-TRNK1-DB-15-A100	1.2	150	100	380	3,75
GE-TRNK1-DB-20-A100	1.5	200	100	430	6,40
GE-TRNK1-DB-25-A100	1.5	250	100	480	8,00
GE-TRNK1-DB-30-A100	1.5	300	100	530	10,00

SS4 SS6 EG HDG

### GE-TRNK1-VB90-A100

90° Vertical Bend  
 90° Dikey çıkış elemanı  
 Внешний угловой элемент 90°

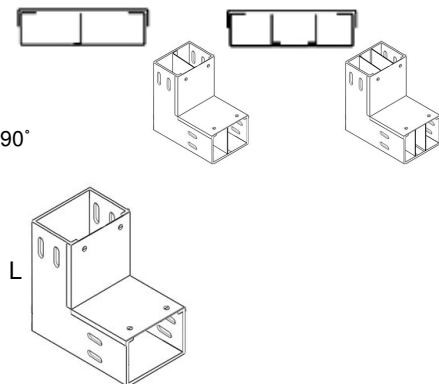
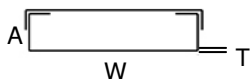

Part No	T	W	A	L	kg
GE-TRNK1-VB90-10-A100	1.2	100	100	200	0,83
GE-TRNK1-VB90-15-A100	1.2	150	100	200	1,00
GE-TRNK1-VB90-20-A100	1.5	200	100	200	1,50
GE-TRNK1-VB90-25-A100	1.5	250	100	200	1,80
GE-TRNK1-VB90-30-A100	1.5	300	100	200	2,10

SS4 SS6 EG HDG

### GE-TRNK1-VB45-A100

45° Vertical Bend  
 45° Dikey çıkış elemanı  
 Внешний угловой элемент 45°

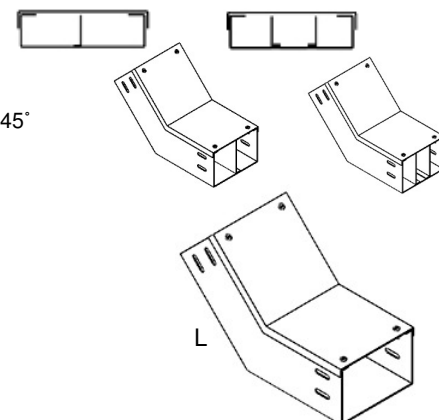
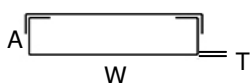

Part No	T	W	A	L	kg
GE-TRNK1-VB45-10-A100	1.2	100	100	340	1,40
GE-TRNK1-VB45-15-A100	1.2	150	100	340	1,75
GE-TRNK1-VB45-20-A100	1.5	200	100	340	2,60
GE-TRNK1-VB45-25-A100	1.5	250	100	340	3,00
GE-TRNK1-VB45-30-A100	1.5	300	100	340	3,40

SS4 SS6 EG HDG

## Cable Trunkings

# 150

**GE-TRNK1-A150**  
 Cable trunking  
 Tranket  
 кабельных лотков

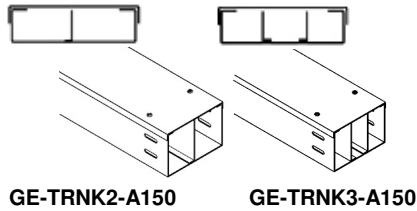

Part No	T	W	A	L	kg/m
GE-TRNK1-15-A150	1.2	150	150	3000	6,05
GE-TRNK1-20-A150	1.5	200	150	3000	8,80
GE-TRNK1-25-A150	1.5	250	150	3000	10,00
GE-TRNK1-30-A150	1.5	300	150	3000	11,20

SS4 SS6 EG HDG

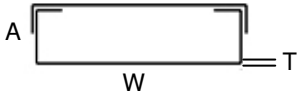

GE-TRNK2-A150 GE-TRNK3-A150

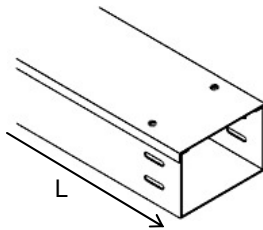

Standard lengths: 3m  
 Available in additional lengths upto 5m upon request.  
 Perforated with slot holes in 10.3 x 26mm.

**GE-TRNK1-D90-A150**  
 90° Flat Bend  
 90° Yatay Dönüş Elemanı  
 Секция угловая горизонтальная 90°

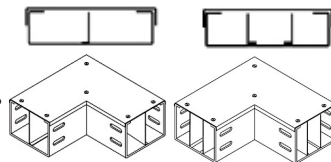

Part No	T	W	A	L	kg
GE-TRNK1-D90-15-A150	1.2	150	150	270	2,40
GE-TRNK1-D90-20-A150	1.5	200	150	320	3,90
GE-TRNK1-D90-25-A150	1.5	250	150	370	5,00
GE-TRNK1-D90-30-A150	1.5	300	150	420	6,10

SS4 SS6 EG HDG

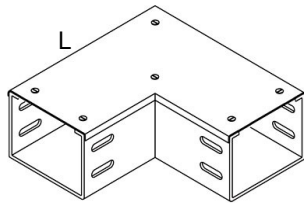

Sample order: GE-TRNK1 D90 5 A150 HDG  
 (Series + Product + Width + Height + Finish)

**GE-TRNK1-D45-A150**  
 45° Flat Bend  
 45° Yatay Dönüş Elemanı  
 Секция угловая горизонтальная 90°

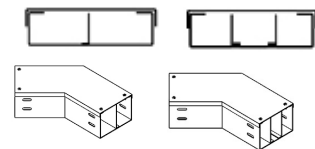

Part No	T	W	A	L	kg
GE-TRNK1-D45-15-A150	1.2	150	150	430	2,60
GE-TRNK1-D45-20-A150	1.5	200	150	480	4,25
GE-TRNK1-D45-25-A150	1.5	250	150	530	5,30
GE-TRNK1-D45-30-A150	1.5	300	150	580	6,50

SS4 SS6 EG HDG

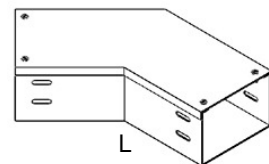

**GE-TRNK-EK-150**  
 Splice Plate  
 Ek Parçası  
 Связующий элемент

Part No	T	W	A	L	kg
GE-TRNK-EK-15-A150	1.2	150	150	100	0,45
GE-TRNK-EK-20-A150	1.5	200	150	100	0,60
GE-TRNK-EK-25-A150	1.5	250	150	100	0,70
GE-TRNK-EK-30-A150	1.5	300	150	100	0,72

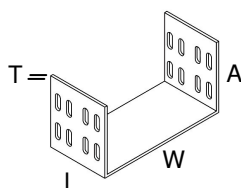

Material options: Stainless steel AISI 304 (L) (A2) / AISI 316 (L) (A4), ST-37-42 Mild Steel, Corten A, Pregalvanized steel, Aluminum  
 Finish options : Hot Dip Galvanized to EN 1461, Electrogalvanized to TS 149, Electrostatic Paint Coated, Prime coated

## Cable Trunkings

## 150

### GE-TRNK1-T-A150

Tee  
 T Elemanı  
 T образное азветвление

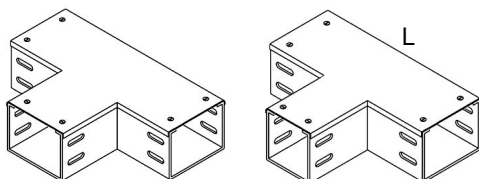
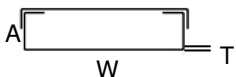
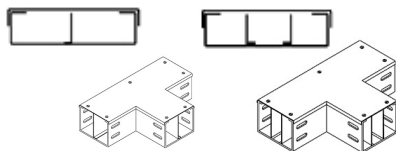

Part No	T	W	A	L	kg
GE-TRNK1-T-15-A150	1.2	150	150	380	3,60
GE-TRNK1-T-20-A150	1.5	200	150	430	5,90
GE-TRNK1-T-25-A150	1.5	250	150	480	7,50
GE-TRNK1-T-30-A150	1.5	300	150	530	9,00

SS4 SS6 EG HDG

### GE-TRNK1-DB-A150

Crossing  
 Dörtlü Bağlantı Elemanı  
 Секция крестообразная

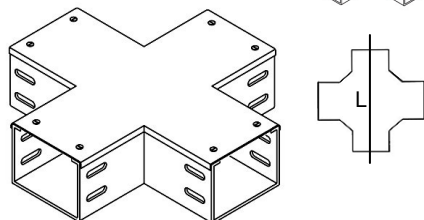
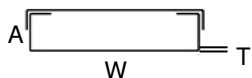
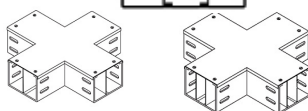

Part No	T	W	A	L	kg
GE-TRNK1-DB-15-A150	1.2	150	150	380	4,50
GE-TRNK1-DB-20-A150	1.5	200	150	430	7,40
GE-TRNK1-DB-25-A150	1.5	250	150	480	9,30
GE-TRNK1-DB-30-A150	1.5	300	150	530	11,25

SS4 SS6 EG HDG

### GE-TRNK1-VB90-A150

90° Vertical Bend  
 90° Dikey çıkış elemanı  
 Внешний угловой элемент 90°

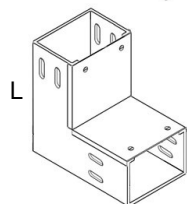
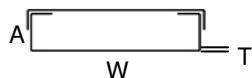
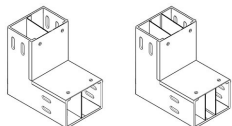

Part No	T	W	A	L	kg
GE-TRNK1-VB90-15-A150	1.2	150	150	200	1,20
GE-TRNK1-VB90-20-A150	1.5	200	150	200	1,80
GE-TRNK1-VB90-25-A150	1.5	250	150	200	2,00
GE-TRNK1-VB90-30-A150	1.5	300	150	200	2,25

SS4 SS6 EG HDG

### GE-TRNK1-VB45-A150

45° Vertical Bend  
 45° Dikey çıkış elemanı  
 Внешний угловой элемент 45°

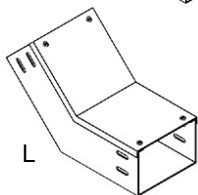
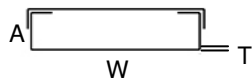
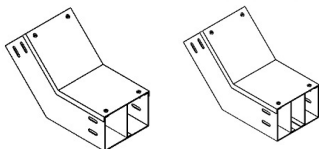

Part No	T	W	A	L	kg
GE-TRNK1-VB45-15-A150	1.2	150	150	340	2,00
GE-TRNK1-VB45-20-A150	1.5	200	150	340	3,00
GE-TRNK1-VB45-25-A150	1.5	250	150	340	3,40
GE-TRNK1-VB45-30-A150	1.5	300	150	340	3,80

SS4 SS6 EG HDG

Material options: Stainless steel AISI 304 (L) (A2) / AISI 316 (L) (A4), ST-37-42 Mild Steel, Corten A, Pregalvanized steel, Aluminum  
 Finish options : Hot Dip Galvanized to EN 1461, Electrogalvanized to TS 149, Electrostatic Paint Coated, Prime coated

## Cable Trunkings

### GE-TRNK-SON

End Plate  
 Sonlandırma Elemanı  
 Единица конца

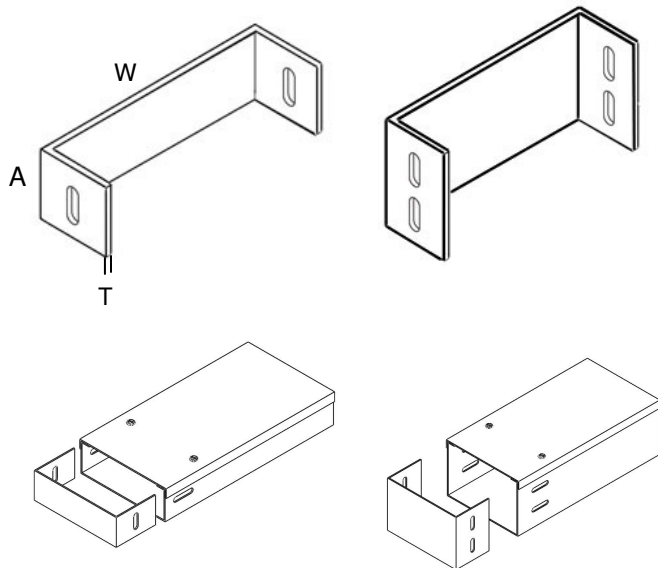

Part No	T	W	A	kg
GE-TRNK-SON-5-A50	1	50	50	0,06
GE-TRNK-SON-7-A50	1	75	50	0,07
GE-TRNK-SON-10-A50	1	100	50	0,08
GE-TRNK-SON-15-A50	1	150	50	0,10
GE-TRNK-SON-20-A50	1	200	50	0,12
GE-TRNK-SON-25-A50	1	250	50	0,14
GE-TRNK-SON-30-A50	1	300	50	0,16
GE-TRNK-SON-7-A75	1,2	75	75	0,13
GE-TRNK-SON-10-A75	1,2	100	75	0,15
GE-TRNK-SON-15-A75	1,2	150	75	0,18
GE-TRNK-SON-20-A75	1,2	200	75	0,22
GE-TRNK-SON-25-A75	1,2	250	75	0,26
GE-TRNK-SON-30-A75	1,2	300	75	0,29
GE-TRNK-SON-7-A100	1,2	75	100	0,18
GE-TRNK-SON-10-A100	1,2	100	100	0,20
GE-TRNK-SON-15-A100	1,2	150	100	0,25
GE-TRNK-SON-20-A100	1,2	200	100	0,30
GE-TRNK-SON-25-A100	1,2	250	100	0,35
GE-TRNK-SON-30-A100	1,2	300	100	0,40
GE-TRNK-SON-15-A150	1,2	150	150	0,45
GE-TRNK-SON-20-A150	1,5	200	150	0,54
GE-TRNK-SON-25-A150	1,5	250	150	0,65
GE-TRNK-SON-30-A150	1,5	300	150	0,72

SS4 SS6 EG HDG

### GE-TRNK-EK

Connector  
 Ek elemanı  
 Связующий элемент

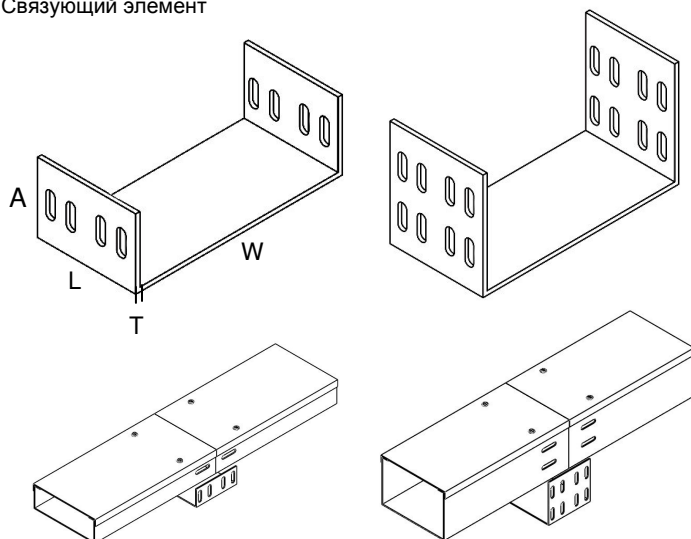

#### Sample order:

GE-TRNK-EK-WIDTH-HEIGHT-FINISH